



Technology Transfer@ Sincrotrone Trieste

Marco Marazzi
marco.marazzi@elettra.trieste.it



Sincrotrone Trieste S.C.p.A.

No profit shareholder company recognized of national interest

Shareholders: Area Science Park, Friuli Venezia Giulia Region, CNR, Invitalia.

Established 25 years ago to build and manage a synchrotron light source to be open internationally

The mission is to promote cultural, social and economic growth through basic and applied research in relevant fields, technical and scientific training, and technology transfer.



Technology Transfer

Science



Industries

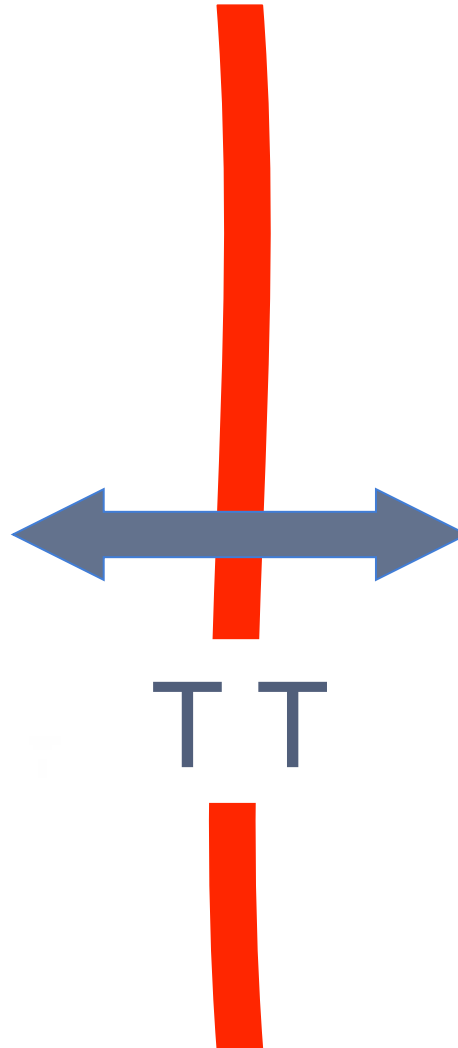
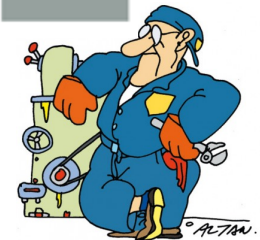



Industrial Liaison Office - HOW

Technology Transfer

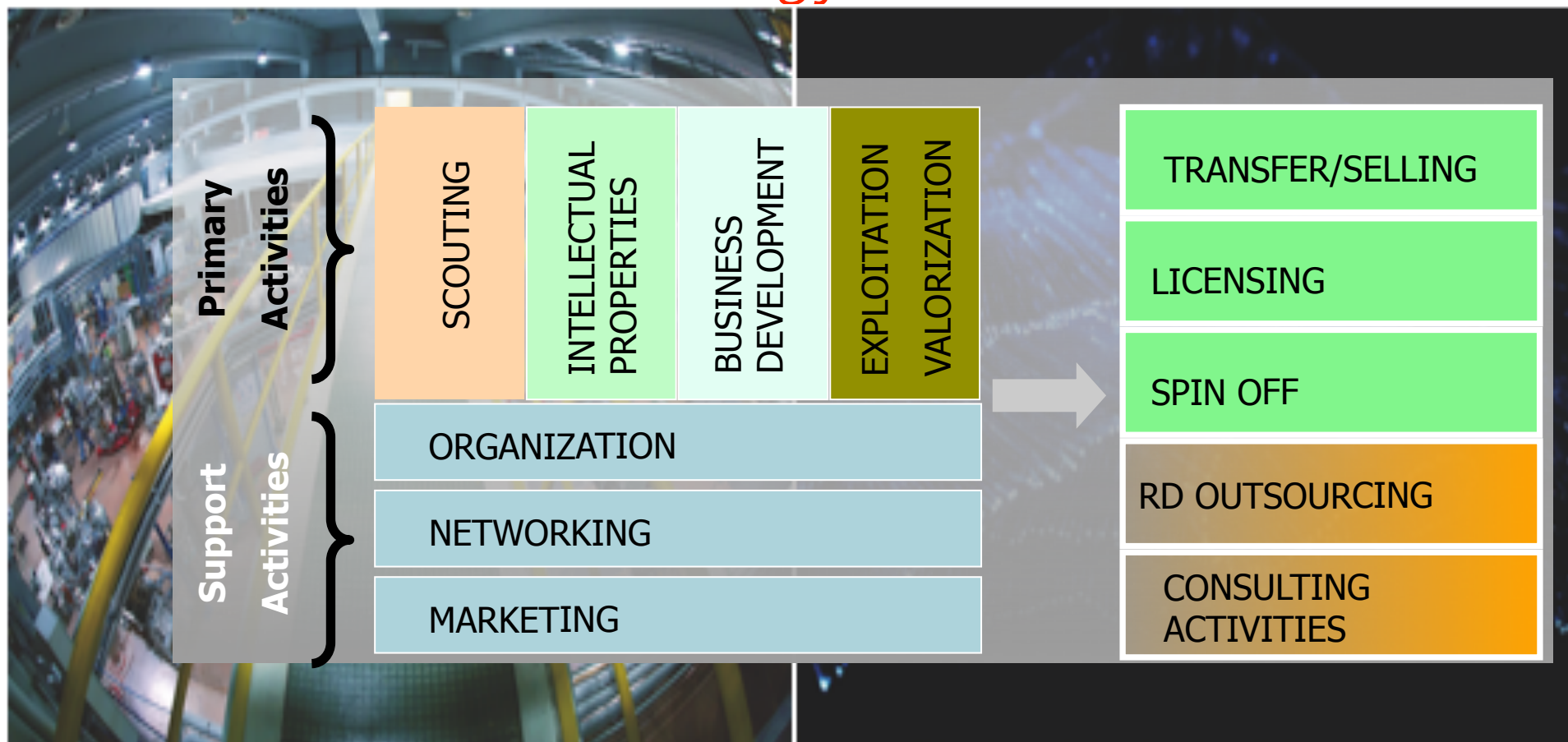



IPR Managing

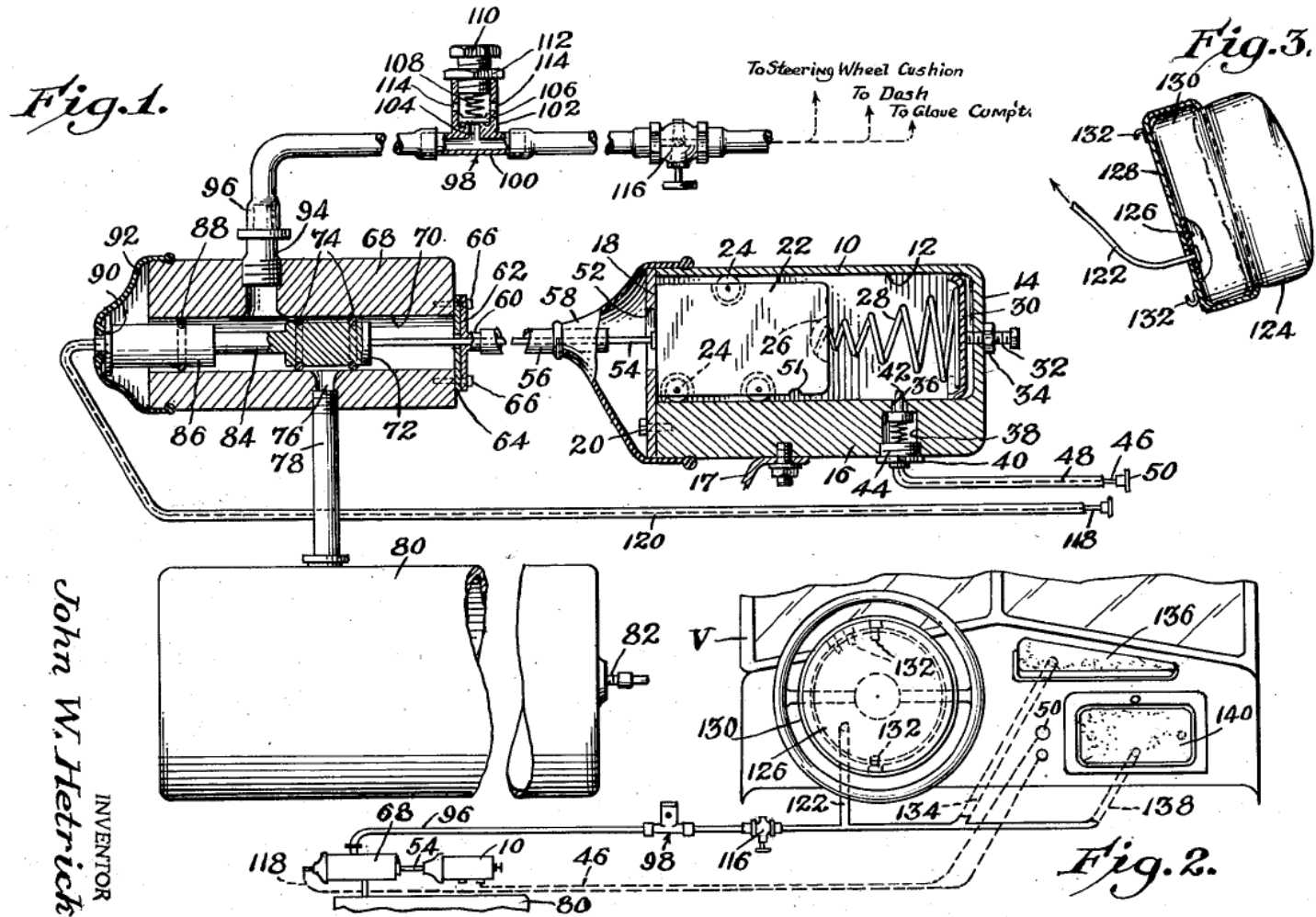



IPR Managing

Aug. 18, 1953

J. W. HETRICK

2,649,311

SAFETY CUSHION ASSEMBLY FOR AUTOMOTIVE VEHICLES

Filed Aug. 5, 1952

When John W. Hetrick and his family were involved in a 1952 car accident, he and his wife threw up hands to protect their child. Hetrick the same year filed an US patent for a "safety cushion assembly for automotive vehicles." It was the first modern airbag.

Airbag systems was adopted by Mercedes on 1980s, when rights on Patent were expired.

Unfortunately, he died in 1975 without seeing adoption of airbag systems.



IPR Managing

- Define Strategy on IPR

Define how to protect your Know How



Define strategies of valorization





IPR Valorization

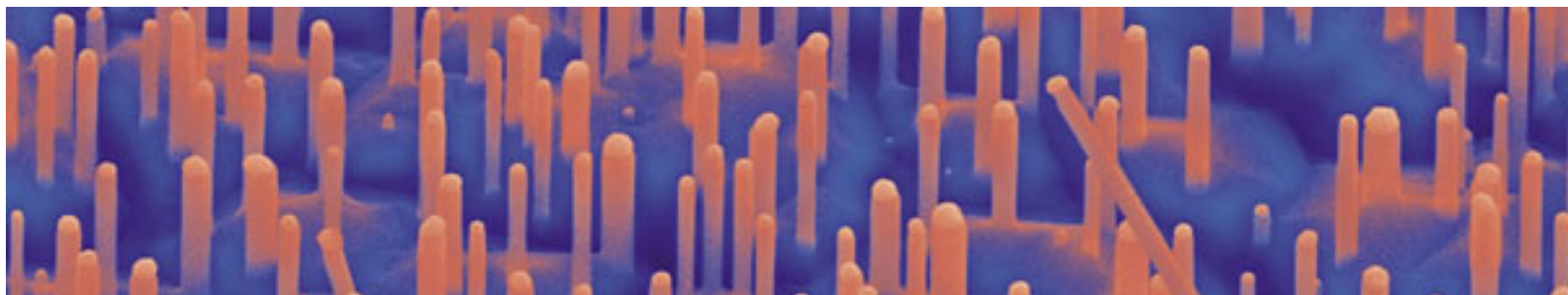
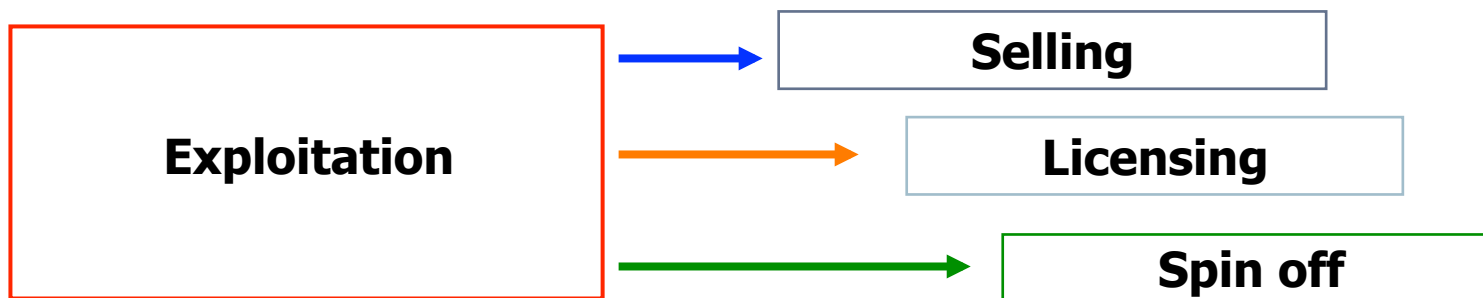



Spin off

Can you create a spin off company
with your Know How?

- **Know how value can be certified by a sworn valuation.**
- **Know How can be transferred in-kind to the capital of a NewCo.**
- **Your partners compensate the value of Know How with venture capital.**



Industrial Liaison Office – Spin off

KYMA born in 2006 as Sincrotrone Trieste spin off to produce undulators for Synchrotron and FEL light sources

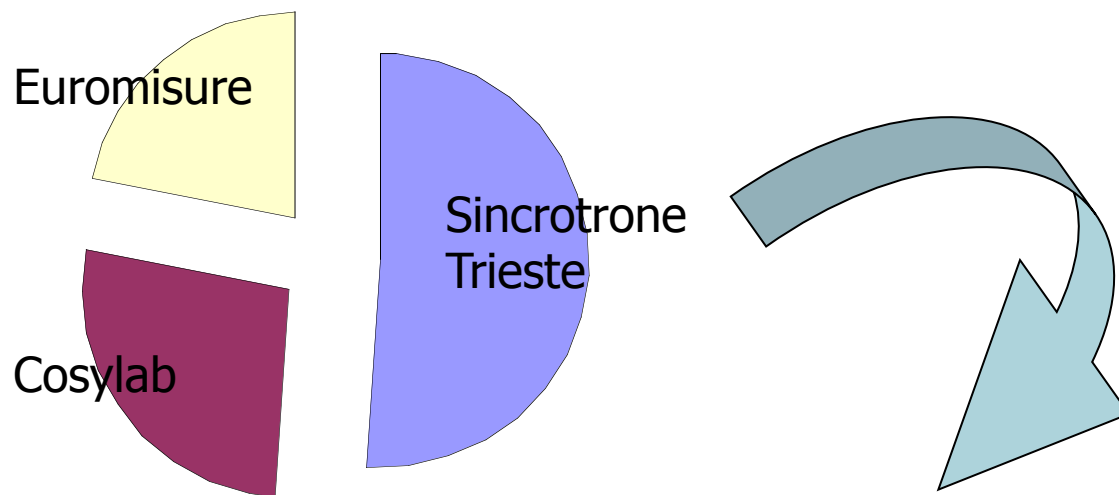



THANKS!
THANKS!

Web link:

ilo.elettra.trieste.it

Profile on LinkedIn:

www.linkedin.com/companies/sincrotrone-trieste-s.c.p.a

YouTube Channel:

www.youtube.com/Sincrotronetrieste